

INSTRUCTIONS FOR THE USE AND CARE OF ZANUSSI WASHING MACHINE

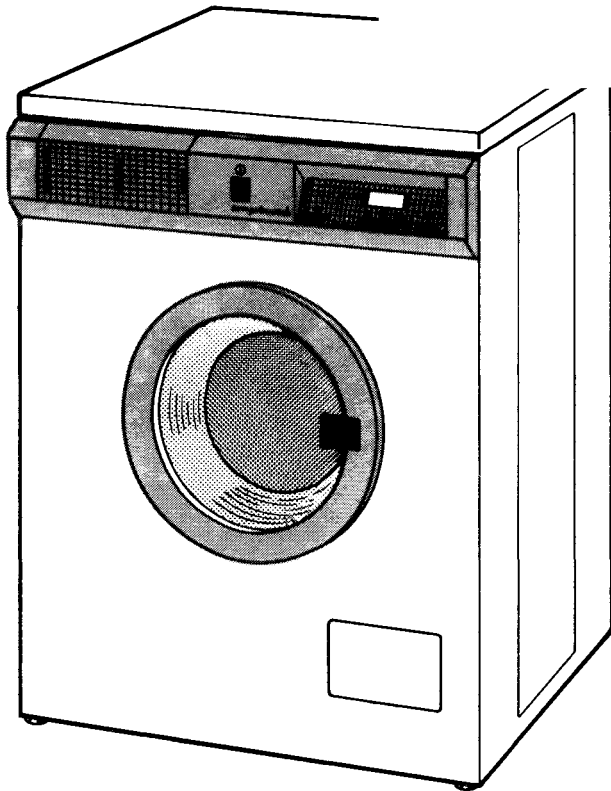

MODEL NO FE 4000

ZANUSSI
The appliance of science

It is most important that this instruction book should be retained with the appliance for future reference. Should the appliance be sold or transferred to another owner, or should you move house and leave the appliance, always ensure that the book is supplied with the appliance in order that the new owner can be acquainted with the functioning of the appliance and the relevant warnings.

Warnings - Washing Machines

THESE WARNINGS ARE PROVIDED IN THE INTEREST OF SAFETY. YOU MUST READ THEM CAREFULLY BEFORE INSTALLING OR USING THE APPLIANCE.

This appliance is designed to be operated by adults. Children should not be allowed to tamper with the controls or play with the product.

It is dangerous to alter the specifications or attempt to modify this product in any way.

Any electrical work required to install this appliance should be carried out by a qualified or competent person.

Any plumbing work required to install this appliance should be carried out by a qualified plumber or competent person.

This product should be serviced by an authorised Zanussi Network Service Centre, and only genuine Zanussi spare parts should be used.

Care must be taken to ensure that the appliance does not stand on the electrical supply cable.

Always unplug the appliance and turn off the water after use.

Do not overload the appliance. See relevant section in instruction book.

Always look through the glass door to check if water has drained before opening the door. If water is present do not open door before draining the water. If in doubt, refer to your instruction book.

This appliance is heavy. Care should be taken when moving it.

All packing and transit bolts must be removed before use. Serious damage can

occur to the product and to property if this is not adhered to. See relevant section in instructions.

The glass door becomes very hot during the washing cycle. Keep children away from the vicinity of the appliance whilst it is in operation.

Leave the porthole door slightly ajar between washes to preserve the door seal.

Do not overload the appliance. See relevant section in instruction book.

Only wash fabrics which are designed to be machine washed. If in doubt, consult the manufacturer of that item.

Before washing, ensure that all pockets are empty and buttons and zips are fastened. Avoid washing frayed or torn articles and treat stains such as paint, ink, rust, and grass before washing. Underwired bras must not be machine washed.

Any objects such as coins, safety pins, nails, screws, stones or any other hard, sharp material can cause extensive damage and must not be placed into the appliance.

Garments which are saturated with petroleum products should not be machine washed. If volatile cleaning fluids are used, care should be taken to ensure that the fluid is removed from the garment before placing in the machine.

Wash small items such as socks, laces, washable belts etc in a washing bag or pillow case as it is possible for such items to slip down between the tub and the inner drum.

Only use the advised quantities of fabric softener. Damage to the fabric can ensue if you over-fill. Refer to the manufacturers' recommendations of quantities.

Pets have been known to climb into washing machines. Please check your drum before use.

Under no circumstances should you attempt to repair the machine yourself. Repairs carried out by inexperienced persons may cause injury or more serious malfunctioning. Contact your local Zanussi Network Centre. Always insist on genuine Zanussi spare parts.

Contents

Page 7	Installation
Page 12	Getting to know your machine
Page 22	Using your machine
Page 26	Looking after your machine
Page 28	Helpful washing hints
Page 29	How to wash...
Page 31	Servicing
Page 33	ZANUSSI Guarantee conditions
Page 34	ZANUSSI 5 year cover

Please note that the specifications of your appliance may differ slightly from those shown in this leaflet.

Specifications

FE 4000

Dimensions

Height	850mm 33.5"
Width	600mm 23.6"
Depth	550mm 22.7"
Weight	176lb 80kg
Capacity	10lb 4.5kg
Revolutions per minute	650 /1100

Power Absorbed	2550W
Heater Rating	2300W
Motor Rating	
Wash	250W
Spin	350W
Voltage	220/240V
Frequency	50Hz

Water Load

Normal	2.9 gals 13 litres
High	4.4 gals 20 litres

Pressure psi

Maximum	110
Minimum (hot)	4
Minimum (cold)	7

A Detergent dispenser

B Programme chart

**C ON/OFF push button
(with pilot lamp)**

D Programmer push button ⤵

E Cycle display

F Prewash push button ⏮

G Half load push button 1/2

H Spin push button 650

I Start/pause push button ⏸

J Drain filter

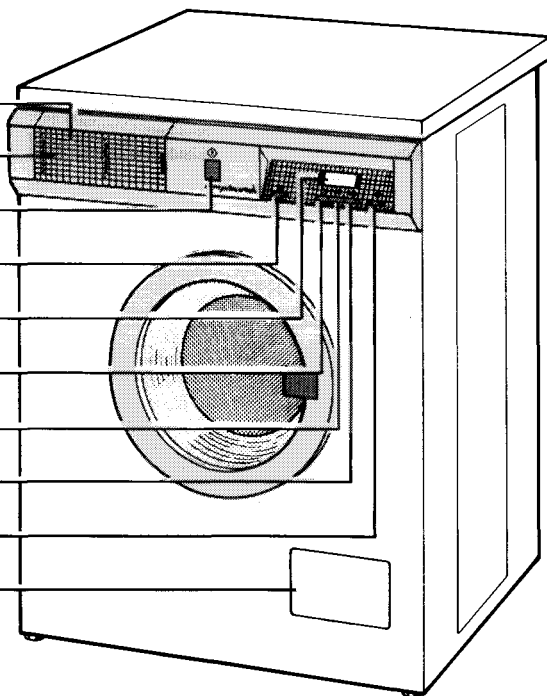

Please note that the external appearance of your appliance may differ slightly from that shown in this instruction book.

Installation

Unpacking

Having removed the outer carton, reinforcing angles, and polythene wrapping, you must take out the internal packing which protected the appliance's «works» during transit.

1
Using the plastic spanner provided, remove the three large bolts from the back of the machine to free the washing drum (figure 1).

2
Each bolt leaves behind a plastic spacer inside the machine, this should be worked loose by inserting a screwdriver into the bolt hole, allowing the spacers to drop to the bottom of the machine.

3
Lay the machine carefully on its back to reveal two pieces of polythene bands in the base (figure 2).
First pull band A, on left hand side then pull band B on the right hand side to withdraw the remaining internal packing, taking care not to catch and damage any of the appliance's internal components in the process.

4
Finally, lift the appliance of the polystyrene base packing and remove the plastic spacers you worked loose earlier. These spacers, together with the three large bolts and other internal packing should be kept in a safe place so they can be used if the machine has to be transported again.

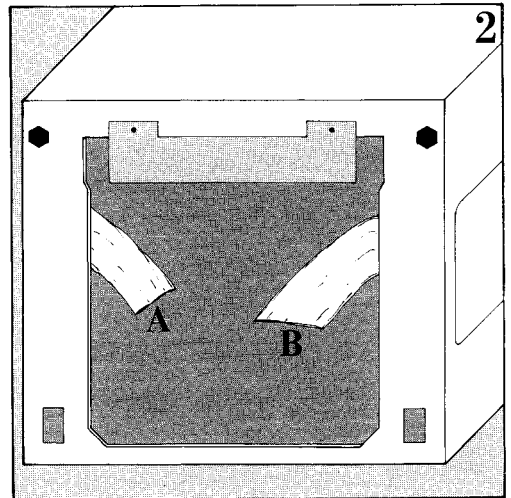
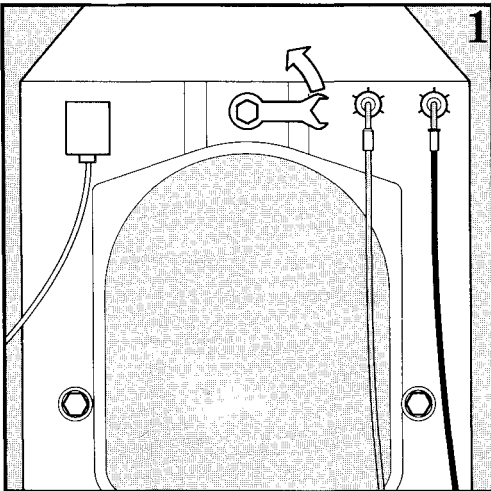

Positioning and levelling

To keep vibration, noise and movement to a minimum, it is essential that the machine is absolutely level. Check this with the aid of a spirit level when the machine is in its permanent operating position. Any adjustments needed can be made by using the open end of the spanner supplied to raise or lower the two adjustable feet at the front of the machine — you merely screw them up or down (figure 3).

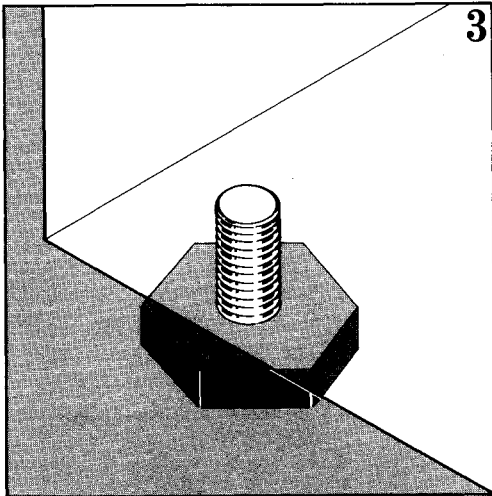

Some vibration is inevitable, especially if mounted on a wooden floor.

Please ensure that when the appliance is installed it is easily accessible for the engineer in the event of a breakdown.

The plumbing connections

Your new Zanussi washing machine has been designed to be permanently plumbed in to your home's water supply and drainage system. However, if this is not possible, it may be connected to suitable existing taps, with the drain hose discharging into a sink.

The appliance has two inlet valves, hot and cold, with female 3/4" BSP thread connectors. If this connection size is not compatible with the plumbing of the existing installation, a variety of connectors are available from good hardware stores and plumbers merchants to suit most domestic plumbing. Any alterations to your existing plumbing must be carried out by a competent person, or qualified plumber.

The inlets on the back of the appliance are colour coded, blue for cold, red for hot. Before connecting the hoses be sure to fit the mesh filters supplied as per diagram.

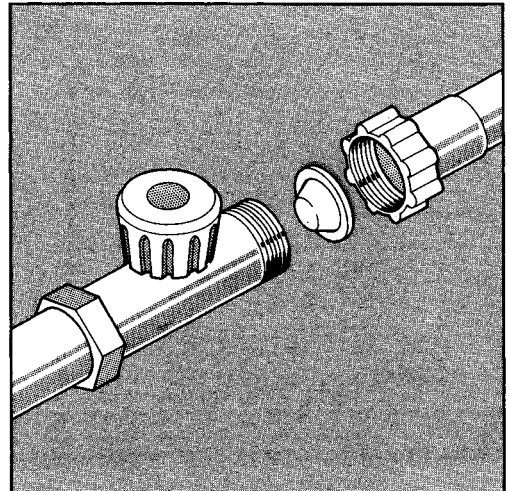

If only a cold water supply is available, connect the two hoses to a cold water outlet by means of a "Y" connection piece.

Installation should comply with local water authority and building regulations' requirements.

The appliance must be given a separate cold water supply and not be connected to a mixer tap, a single outlet water heater or a booster pump. A minimum water pressure of 7 psi is required for the safe operation of the appliance.

If you cannot make the cold water connection direct from the rising mains, you may be able to operate the appliance from your cold water storage system.

There should be a minimum distance of 5.02 m (16.5 ft) between the appliance's inlet and the bottom of the tank.

There will be sufficient pressure for the hot water supply from the hot water cylinder if the height between the appliance's inlet and the bottom of the cold water storage cistern (not between the appliance and hot water cylinder) is at least 2.74 m (9 ft).

If you are operating the appliance on the minimum pressure of 7 psi, it may fill slowly. This flow can be increased by removing the small restrictor contained within the inlet valve. In order to remove the restrictor, first turn the water off and unplug the appliance. Disconnect the water supply hose from the inlet valve, pull out the mesh filter inside the valve. Remove the restrictor (which is a small round washer) with the aid of thin-nosed pliers. Replace mesh filter and re-fit hose.

If you intend the drain hose from the machine to empty into a sink, make sure the sink is empty and that the plug hole is not blocked.

Where the machine is permanently plumbed in, hook the end of the hose into a standpipe installed for the purpose. It should have an internal diameter of at least 38mm (1½") thus leaving an air gap between hose and pipe, and should be designed in such a way that the water level within it never covers the end of the hose.

Important: Before connecting up the machine to new pipework or to pipework that has not been used for some time, run off a reasonable amount of water to flush out any debris that may have collected in the pipes.

Whether discharging into a sink or a drainpipe check that the end of the drain hose is neither too high nor too low. The top of the curve in the hose's end should be no more than 85cm (34") and no less than 50cm (20") above floor level (figure 4).

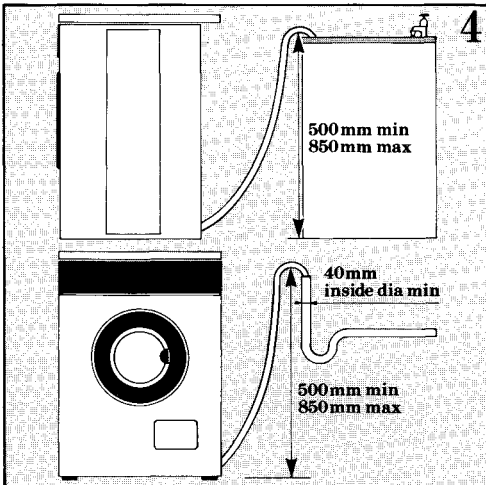

Finally, make sure that with the machine in position, the drain hose is not obstructed, blocked or bent so sharply that water cannot flow freely.

The electrical connections

WARNING: THIS APPLIANCE MUST BE EARTHED

The manufacturer declines any liability should this safety measure not be observed.

If the plug that is fitted to your appliance is not suitable for your socket outlet, it must be cut off and the appropriate plug fitted.

The cut off plug should be disposed of to prevent the hazard of electric shocks in case it should be plugged into a 13 Amp socket in another part of your home.

IMPORTANT

The wires in this mains lead are coloured in accordance with the following code:

GREEN AND YELLOW - EARTH

BLUE - NEUTRAL

BROWN - LIVE

If you fit your own plug, the colours of the wires in the mains lead of your appliance may not correspond with the markings identifying the terminals in your plug, this is what you have to do: Connect the green and yellow (earth) wire to the terminal in the plug which is marked with the letter «E» or the earth \perp symbol or coloured green, or green and yellow.

Connect the blue (neutral) wire to the terminal in the plug which is marked with the letter «N» or coloured black.

Connect the brown (live) wire to the terminal which is marked with the letter «L» or coloured red.

The plug moulded on to the cord incorporates a fuse. For replacement, use a 13 Amp BS 1362 fuse. Only ASTA approved fuses should be used.

The fuse cover/carrier must be replaced in the event of changing fuse.

The right fuse cover/carrier colour is the one shown by the coloured insert at the base of the plug.





The plug must not be used if the fuse cover/carrier is lost. A replacement cover/carrier must be obtained from Zanussi Service Agents whose addresses are listed on the attached «Zanussi Service Agents Nationwide».

This appliance complies with E.E.C. directive no. 87 / 308 of 2.6.87 relative to radio interference suppression.

For correct functioning of the washing machine, the mains must be provided with a suitable earth connection.

Getting to know your machine

The controls and how to use them

- A** Detergent dispenser
- B** Programme chart
- C** ON/OFF push button 
(with pilot lamp)
- D** Programmer push button 
- E** Cycle display
- F** Prewash push button 
- G** Half load push button 
- H** Spin push button **650**
- I** Start/pause push button 
- J** Drain filter

A Detergent dispenser

The dispenser has three compartments - two for detergent (**a** and **b**) and one for fabric conditioner (**c**), (see figure 6 page 23).

The fabric conditioner compartment is fitted with a removable filter. To open the dispenser, pull the handle, which is at the lower half, gently.

B Programme chart

This chart will help you to select the correct wash programme. The number and wash programmes correspond to those used in the detailed charts on pages 16-20.

C ON/OFF pushbutton

Press this button to activate the washing machine programmes. The pilot light comes on and a zero appears in the display window.

After a few seconds the key symbol  flashes to indicate that the door can still be opened.

D Programmer pushbutton

By pressing this pushbutton the 23 numbers that mark the various wash cycles appear in sequence in the display window. (see programme chart on page 16-20).

If the button is pressed during the wash cycle the display shows the number and characteristics of the cycle in progress. When released the remaining time before the cycle is completed is displayed.

E Cycle display

The liquid crystal display shows the following information:

The 23 numbers which identify the cycle appear in the window in sequence when the Programmer Pushbutton is pressed. During the selection of the cycle, beside the number which identifies the cycle, other characters will appear when the following buttons are pressed:

Prewash 

Half load 

Spin Speed **650**

Once the Start Button has been pressed, the time which it will take for the programme to be completed is shown in the window.

The time is being constantly reassessed according to the water temperature and washing conditions, and will update at regular intervals. Please note that the readout for the quickwash programme does not update itself as frequently as the rest of the programmes.

A key symbol is shown to indicate that the washing machine door is locked. At the end of the cycle the display shows zero. After 1 - 2 minutes the key symbol  starts to flash to indicate that the door can be opened.

Always remember to drain the water before opening the door.

F Prewash pushbutton

This button should be depressed to wash heavily soiled clothes. In this case, the main wash will be preceded by a prewash (see charts pages 16-19).

The Prewash symbol  appears on the display window. When this button is pressed again, the prewash is cancelled.

G Half load pushbutton

By depressing this button the number of rinses is reduced. This is useful if you want to wash half loads (up to 2 kg of cotton or linen items, or up to 1 kg of some synthetic fabrics).

The half load facility is not available on all programmes, and if the symbol does not appear in the window, the programme is not suitable for a half load.

To clear the half load function, press the button again.

Do not use this pushbutton for washing towelling or other highly absorbent fabrics: the machine jams and an alarm code will appear on the display (E) (see servicing on pages 31-32).

H Spin pushbutton 650

By pressing this button in at the beginning of an energetic wash cycle, the spin speed is reduced from 1100 r.p.m. to 650 r.p.m.. The Spin Speed symbol **650** appears in the display window.

Pressing the button again returns the spin speed to 1100 r.p.m.

I Start pushbutton

By pressing this button the programme will begin.

Once the button has been pressed, the length of time which it will take for the programme to be completed is shown in the display window; the key symbol  stops flashing to indicate that the door is now locked. If the key symbol continues to flash it indicates that the door has not been properly closed.

To cancel the programme during a wash cycle, press the Start Button for approximately 5 seconds. This cancels the cycle in progress and a zero  is shown in the display window.

At the end of a gentle wash cycle, which finishes with the fabric being suspended in water, if the Start Button is pressed the machine automatically drains and spins briefly.

After 1-2 minutes at the end of the wash cycle, the key symbol  flashes to indicate that the door can be opened.

Once the Start Button has been pressed and the programme is in operation, the Prewash, Half Load and Spin Speed Buttons become inoperative.

Should there be a power failure, the selected programme remains in the washing machine's memory for between 5-10 minutes. If the power is restored within this time then the wash cycle will continue automatically.

J Drain filter

This is situated behind the small flap cover at the base of the cabinet. It will need cleaning from time to time. (See page 27).

The washing programme

The washing machine has 16 programmes and 7 additional programmes such as «rinse» or «spin only» (see charts pages 16-20). Each washing programme is designed for a specific type of fabric, for example cotton, nylon, mixed fabrics such as polycotton, etc. They follow the International Textile Care Labelling Code (ITCLC) which is used for wash labels on garments and household linen as well as on washing powder packets. This makes it simple to choose the right programme for the fabric you are washing.

The energetic wash cycles for robust fabrics are completely automatic taking the clothes through washing, rinsing, spinning and draining.



The gentle wash cycles are for minimum iron, drip dry and delicate fabrics. The machine stops after the last rinse before the water draining and spinning (only on programmes 3-4-6-8-12-15).

The clothes are left suspended in water to prevent them becoming creased by remaining in the bottom of the wash tub in a damp state after spinning.

To complete the cycle, press in again the START pushbutton for water draining followed by a short spin.

Energetic wash cycle

For cotton, linen and viscose (rayon) fabrics
Recommended wash load: 4.5 kg (10 lb) max







Wash cycle (cycle number on programme chart)	Dispenser compartment a b washing powder	c fabric conditioner	ITCLC Wash cycle symbol	Wash fabrics description and fabric guide
1 Whites heavy soil Press button U if required	(a) b	c		White cottons and linens without special finishes. Prewash in water at 30°C (normal level). Main wash in water at 90°C (normal level). 4 cold water rinses (high level). Spinning.
2 Fast coloureds heavy soil Press button U if required	(a) b	c		Cottons, linens and viscose. Prewash in water at 30°C (normal level). Main wash in water at 60°C (normal level). 4 cold water rinses (high level). Spinning.
5 Non fast coloureds Press button U if required	(a) b	c		Cottons, linens and viscose. Prewash in water at 30°C (normal level). Main wash in water at 40°C (normal level). 4 cold water rinses (high level). Spinning.
9 White special cottons	b	c		Cotton articles with special finishes drip-drying. Main wash in water at 90°C (normal level). 3 cold water rinses (high level). Stop with water still in drum. To drain (with 1 minute final spin at 650 r.p.m.) press START button again.

Wash cycle (cycle number on programme chart)	Dispenser compartment a b washing powder	c fabric conditioner	ITCLC Wash cycle symbol	Wash fabrics description and fabric guide
10 White heavy soil (Economy) Press button U if required	(a) b	c		White cottons and linens without special finishes. Prewash in water at 30°C (normal level). Long main wash in water at 60°C (normal level). 4 cold water rinses (high level). Spinning.
11 Fast coloureds heavy soil (Economy) Press button U if required	(a) b	c		Cottons, linens and viscose. Prewash in water at 30°C (normal level). Long main wash in water at 40°C (normal level). 4 cold water rinses (high level). Spinning.
17 Rinses		c		Cottons, linens and viscose. 4 cold water rinses (high level). Spinning.
19 Special treatments		c		1 cold water rinse (high level). Spinning.
21 Spin only				Spinning for about 6 minutes with simultaneous water draining. This is preceded and followed by slow rotations of the drum.

Gentle wash cycle

For delicates, synthetics including acrylics, acetates, triacetates, machine washable woollens and synthetics mixed with polyester and wool.

Recommended wash load: 1.5 - 2 kg (3-5 lb); wool max. 1 kg (2 lb)

Wash cycle (cycle number on programme chart)	Dispenser compartment a b washing powder	c fabric conditioner	ITCLC wash cycle symbol	Wash fabrics description and fabric guide
3 Whites heavy soil Press button  if required	(a) b	c		White nylon and polyester/cotton mixtures. Prewash in water at 30°C (normal level). Main wash in water at 60°C (normal level). 3 cold water rinses (high level). Stop with water still in drum.
4 Minimum iron Press button  if required	(a) b	c		White nylon and polyester/cotton mixtures. Prewash in water at 30°C (normal level). Main wash in water at 50°C (normal level). 3 cold water rinses (high level). Stop with water still in drum.
6 Delicates Press button  if required	(a) b	c		Acrylics, acetates, triacetates and wool mixtures. Prewash in water at 30°C (high level). Main wash in water at 40°C (high level). 3 cold water rinses (high level). Stop with water still in drum.
7 Woollens 	b	c		Machine washable woollens and mixtures with cotton or viscose; blankets. Main wash in water at 35 °C (high level). 3 cold water rinses (high level). Drain and short spin.

Wash cycle (cycle number on programme chart)	Dispenser compartment a b washing powder	c fabric conditioner	ITCLC wash cycle symbol	Wash fabrics description and fabric guide
8 Silks Press button U if required	(a) b	c		Silks and printed acetate fabrics. Prewash in water at 30°C (high level). Main wash in water at 30°C (high level). 3 cold water rinses (high level). Stop with water still in drum.
12 White heavy soil (Economy) Press button U if required	(a) b	c		White nylon and polyester/cotton mixtures. Prewash in water at 30°C (normal level). Long main wash in water at 40°C (normal level). 3 cold water rinses (high level). Stop with water still in drum.
13 Multi- fabrics	b	c		Mixed load of cotton and synthetics Main wash at 40°C (high level) alternating with 10 minute pauses for a maximum of 2 hours. When it is felt that there has been sufficient wash time press the START Button to advance the programme. 3 cold water rinses (high level). Drain and short spin.
14 Quick-wash	b	c		Delicates, lightly soiled. Main wash in water at 30°C (normal level). 2 cold water rinses (high level). Drain and short spin.

Wash cycle (cycle number on programme chart)	Dispenser compartment a b washing powder	c fabric conditioner	ITCLC wash cycle symbol	Wash fabrics description and fabric guide
15 Delicates (Cold wash)	b	c		Acrylics, acetates, triacetates, Wool mixtures. Main wash in cold water (high level). 3 cold water rinses (high level). Stop with water still in drum.
16 Woollens (Cold wash)	b	c		Machine washable woollens and mixtures with cotton or viscose; blankets. Main wash in cold water (high level). 3 cold water rinses (high level). Drain and short spin.
18 Rinses		c		3 cold water rinses (high level). Drain and short spin.
20 Special treatments		c		1 cold water rinse (high level). Drain and short spin.
22 Short spin only				Water draining followed by a short spin at 650 r.p.m.
23 Drain				Water draining.

Note: There is no water draining after the last rinse of the gentle wash cycles. This prevents the clothes from creasing if they are left in the machine at the end of the wash cycle.

To drain the water, press the START pushbutton; a brief spinning action will also follow.

Warning

Do not open the machine door until one of the draining programmes has been completed. If you do, there will be a flood.

Water filling

cold/30°/40°C programmes - cold water filling
50°/60°C programmes - hot and cold filling
95°C programmes - hot water filling only.

Should you need to check the water filling temperature, use the above information for guidance.

Using your machine

Sorting the wash

Sort the clothes and household linen according to fabric, colour fastness and degree of soiling, following the charts on pages 16-20. **Check with the wash care label sewn to the garment or article; this should have a number in a wash tub symbol which corresponds with the number shown on the charts.** For example, if your sheets have a label with number 95 in the wash tub you can choose either programme 1 or 9 depending on whether the articles are lightly or heavily soiled. If the garment has no label, choose the appropriate programme for the fabric. If you are uncertain what fabric this is, always choose one of the gentle wash cycles such as 3 or 12. Be cautious with coloured items unless they are labelled colourfast, wash them separately by hand, or use programme for non-fast coloureds.

For the best results wash a full load.
4.5kg (10lb) of cottons
1.5-2kg (3-5lb) synthetics
1kg (2lb) machine washable woollens.

Until you are familiar with the size of a full load, weigh the articles on the kitchen or bathroom scales. Try to mix large and small items in each load. If you cannot make up a full load of similar items (eg cotton sheets and towels) make up a load of any polycotton and cotton items, and use one of the lower temperature washes.

Remember, however, that white cotton and linen should be washed at higher temperature (95°C) every third wash to keep them a good colour.

Loading the clothes

Open the drum loading door by pulling the catch forward (figure 5). Put the sorted clothes into the drum one by one, shaking them out first. Alternate large and small items.

Be sure all pockets are empty, buttons and zips fastened. Avoid washing frayed or torn articles, and treat stains such as paint, ink, rust and grass before washing (see page 30).

Warning: The glass porthole door can reach high temperatures during washing phases. Please ensure young children do not touch this area of the appliance.

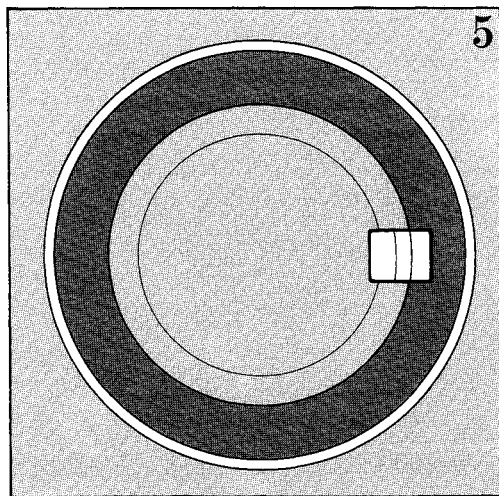

Don't put laundry on the door!

Once the machine is loaded close the door firmly. Then put the washing powder and conditioner (if required) into the dispenser.

Choosing the right washing powder

Always use a low lather powder. This is important as too much lather prevents the articles from tumbling freely and being properly cleansed.

Ariel automatic is specially designed to complement the cleaning action of the machine.

Filling with washing powder

The washing powder dispenser has three compartments (figure 6). Compartment «a» is for the prewash powder, «b» for the main wash powder, and «c» for fabric conditioner. The same wash powder can be used for the pre and main wash

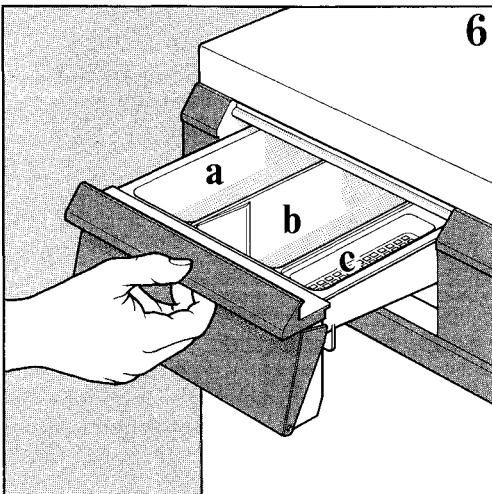

cycles. Pull out the dispenser and add the measured amount of powder, following the directions on the wash powder packet (see also Table which follows). Be sure to use enough powder — this is essential to get the clothes really clean. Once the dispenser is filled, close it by pushing it in gently. This is particularly important if you are using fabric conditioner because if the drawer is slammed it will cause the conditioner to enter the machine prematurely.

Amount of wash powder in grammes for a full load

Hardness	Pre-wash	Main wash following pre-wash	Main wash
Soft	30	120	130
Average	60	135	160
Hard	90	185	230
Very hard	125	235	270

For half loads use $\frac{3}{4}$ of quantity.

For information regarding the degrees of hardness of water in your area, ask the local Water Authority.

Liquid detergents

Liquid detergents may be very useful above all for the low and medium temperature washing of delicate items or those which are not very dirty.

The dispenser drawer also allows the use of liquid detergents.

In this case, you must select programmes without prewash.

The liquid detergent should be poured into the compartment «b» immediately before starting the programme.

Using fabric conditioners

When you want to use a conditioner, put the measured amount (follow manufacturers' instructions) into compartment «c» in the washing powder dispenser at the same time as you put in the washing powder. **Be careful not to fill the compartment above the level of the filter.** The conditioner will be automatically used by the machine at the appropriate time. Remember to close the drawer (fig. 6) gently.

To start the machine

Check that:

- the main switch is on;
- the door is properly closed;
- the water is turned on.

Press the ON/OFF pushbutton (the pilot lamp lights up) and select the programme required by pressing the programmer pushbutton until the required programme number is shown in the window display (see Programme Chart on pages 16-20).

Press the Start pushbutton; the machine will automatically carry out all the operations up to the end of the chosen

programme. Then it will stop. The pilot light will not go out until the ON/OFF button is pressed to switch the machine off.

If after the start of a programme you find that you have selected the wrong one, it can be cancelled by pressing the Start button in for approximately 5 seconds. Then reselect a programme by pressing the Programmer button until the cycle number you require is shown in the display window.

To restart the washing cycle, push the Start button.

At the end of the programme push the ON/OFF button to switch the machine off.

Unloading the clothes

The drum door remains automatically locked for 1-2 minutes after the programme has finished. The door can then be opened and the machine unloaded. **If you have been using a gentle wash cycle do not forget to set the machine to drain the water by pressing the start pushbutton before opening the door.**

Additional programme

Spin only

This programme can be used to remove water from hand washed articles or any laundry which may have got wet but does not need washing. For example, washing left on the line during a rainstorm.

See pages 17 and 20.

The wash symbols

The familiar wash code symbols which are found on the care labels in most clothes will gradually disappear and a new set of codes will be introduced. This change is due to changes in fabrics and detergents

and because people are tending to use fewer wash programmes and mix fabrics in one load. The change will bring the codes into line with the labelling used in the rest of Europe.

Old Symbol	New Symbol	Wash Action	Fabric
		Normal (Maximum)	White Cotton or Linen without Special Finishes.
		Normal (Maximum)	Cotton, Linen or Viscose without Special Finishes Colourfast at 60 °C.
	No longer used. White Nylon, Polyester/Cotton mixtures now included in		
		Reduced (Medium)	Nylon, Polyester/Cotton, Viscose with Special Finishes: Cotton/Acrylic Mix.
		Normal (Maximum)	Cotton, Linen or Viscose Colourfast at 40 °C but not 60 °C.
		Reduced (Medium)	Acrylics, Acetate, Triacetate, Wool mixes, Polyester/wool blends.
		Much Reduced (Minimum)	Wool, wool mixes, Silks.
	No longer used. Silk now included in ; printed acetate included in .		
	No longer used.		

The new symbols have been used on the Programme Guide of this machine, and are listed on pages 16 and 18.

The new wash symbols will also appear on the side of Washing Powder packets.

Looking after your machine

Important: Make sure that the machine is unplugged and the water taps turned off before undertaking any kind of maintenance.

General care and cleaning

Wipe round the rubber door seal to remove the water which collects in it.

From time to time clean plated, polished and plastic parts and the glass porthole door with a soft damp cloth. Never use abrasive powders.

Wipe over the exterior cabinet with a lukewarm solution of a mild liquid cleaner, rinse and dry thoroughly. From time to time, apply a little wax furniture cream with a soft cloth.

Cleaning the drain filter

Unscrew and pull out the filter (figure 7-8).

Underneath the filter there is a small extractable gutter which makes it easier to collect any residual water that might flow out when the filter is removed. Remove any object or fluff and replace the filter.

This filter should be checked after every wash.

Cleaning inlet filters

These are situated at the back of the machine and should be inspected from time to time. Turn off the water taps.

Unscrew the hoses and remove the mesh filter lodged just inside the hose. Run them under a fast running tap to remove any sediment. Replace the wire filters and the hoses firmly.

Cleaning the washing powder dispenser

Wipe it out after every wash.

From time to time it will need more thorough cleaning to clear out all the deposit. Remove the drawer completely with a sharp pull outwards. When you replace it, if you find that it doesn't slide right in again give it a sharp tap with the palm of your hand.

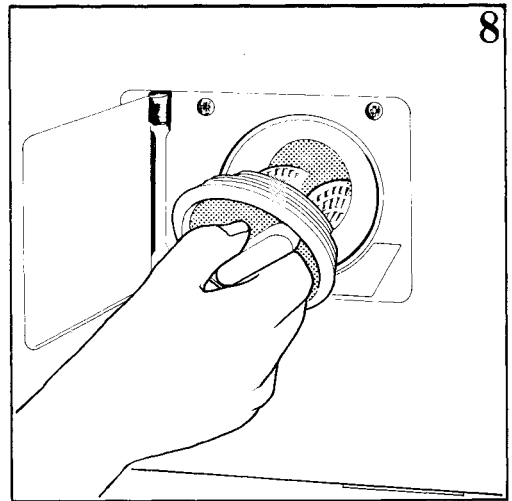
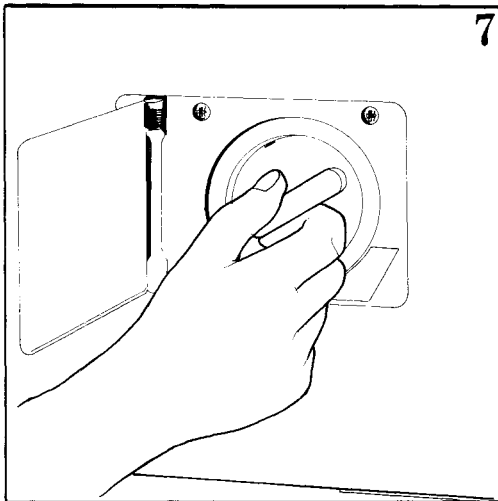

Helpful tips for successful washing

Here are some practical hints to help you get the best washing results.

Don't overload the machine. The clothes will not move around freely and the washing powder may not dissolve properly.

Always use a low lather washing powder specially made for front loading machines. Excessive foaming gives an unsatisfactory wash and may even harm the machine. The quantity of washing powder required depends on the amount of laundry and how soiled it is. It may therefore be necessary to vary the quantities suggested on page 23. You will be able to tell if you need to do this when you are used to the machine.

Don't put washing powder into the dispenser until just before starting a programme. If the powder is left for any length of time in the dispenser it may form lumps which are difficult to dissolve.

For best results do not wash more than 1kg (2lb) of woollen articles at a time.

Wash only woollen articles marked «machine washable».

For best results do not wash more than 1.5-2kg (3-5lb) of synthetic fabrics in one load. Synthetic fabrics need plenty of room to move around or they tend to crease.

Clothes should be sorted according to the fabric — colour fastness and degree of soiling (see page 22).

Mend open seams and tears before washing.

Close zips, secure buttons.

Collect laces, washable belts, socks etc and put them in a bag for washing.

Empty pockets. **(This is important as should a coin become lodged between the tub and drum it can cause extensive damage).**

Remove spots of rust, paint, ink and grass stains before washing (see instructions page 30).

Don't wash light coloured fabrics with dark ones. One may leave specks of fluff on the other.

Don't risk washing coloured articles unless you are sure they are colourfast. It's worth hand washing the article to find out.

If you live in a hard water district, you can add water softening powder to the washing machine in compartment "b".

For the quantity of water softener to use, see packet directions.

How to wash

Nappies

Leave the soiled nappies soaking in a solution of proprietary nappy cleaner. When there are sufficient for a wash, drain off the water and rinse by hand in cold water (this is advisable as some nappy cleansers have an adverse effect on the rubber door seal), then transfer the nappies to the washing machine. Select the programme 2/ (fast spin) to remove excess solution. Then wash the nappies on programme 1 (without prewash \square). Dry and air them thoroughly.

Blankets

Only wash blankets which are labelled as suitable for machine washing. Use wash programme 7 (woollens) followed by drain and spin which will remove the excess water and leave the blanket ready to tumble dry or hang out on a line.

Curtains

Check that the fabric is washable. Remove all the curtain hooks and if the heading is drawn up by means of curtain tape, release the strings to allow the fabric to spread flat. Weigh the curtains and decide if you can wash them in one or more loads. Select the correct

programme for the fabric. If the curtains have not been washed for some time they may be dusty, in which case it is a good idea to rinse them on programme 1/8. After draining, start the suitable wash programme.

Dyeing

You can dye fabrics successfully in the machine but it is essential to buy a good proprietary dye and to read the manufacturer's instructions carefully. Make sure that the fabric is suitable. The dye instructions will guide you on this point. Then wash the article to make sure it is thoroughly clean, using programme 1 or 3 (without prewash \square) according to the fabric. Then follow the instructions for machine dyeing. Immediately after you have removed the dyed material from the machine, set it to programme 5 (without prewash \square) to clean all traces of dye from the machine. It is not absolutely necessary to add washing powder to the dispenser for this, however you can add it if you prefer.

Stain removal

Some stains will not be removed in the wash. It is wise to treat them before laundering.

The following are simple but effective treatments to use on any washable fabric. Treat the stain as soon as possible and launder afterwards to remove any residual stain.

Ballpoint and felt-tip ink:

Dab with methylated spirit on cotton, wool (not on acetate or triacetate fabric).

Fountain pen ink:

Sponge with cold water to flush out as much ink as possible, or hold the fabric under running cold water. Launder and treat any remaining stains with lemon juice.

Grass stains:

Dab with methylated spirit (not on acetate or triacetate). Rinse in clear water.

Oil:

If heavy stains from cycle chain or car oil do not come out in the wash, treat them with a proprietary grease solvent.

Paint: Emulsion:

Sponge immediately with cold water and then launder. If the stain has dried, soften it with methylated spirit or a proprietary paint brush cleaner. (Test an inconspicuous corner of the fabric first).

Gloss:

Dab with methylated spirit or proprietary paint brush cleaner. (Test fabric first).

Rust (iron mould):

Rub with lemon juice and then sprinkle salt over the stain and leave for an hour. If subsequent washing does not remove the stain, use a proprietary rust cleaner following manufacturer's directions.

Servicing

If, having followed these instructions carefully, your machine fails to work properly, contact your local Zanussi Service Network, giving the full model number and date of purchase if the appliance is under guarantee.

Details of your local Zanussi Network Service Centre can be found by looking in the White Pages phone book under Zanussi.

Before you do that, though, it is worth making a few simple checks yourself .

If the machine won't start...

Ensure that the Start Pushbutton has been pressed in.

Make sure that the door of the machine is firmly shut.

Make sure that the appliance is properly plugged in and that the socket switch (if any) is in the «on» position.

Check that there is power at the socket by plugging in an appliance you know to be working — a small lamp, for example. If this too fails to work, check the main circuit fuses in your home's consumer unit or main fuse box.

If the machine won't fill...

Make sure that all water taps are turned on

Make sure that that all water taps are turned on

Check that there is sufficient water pressure. A way to check this is to place a

two gallon bucket under the water feed pipe to the appliance and turn on the tap(s). The bucket should fill in about one minute.

If the machine won't drain or spin...

Unhook the drain hose from the drain pipe or sink and hold the hose over a bowl on the floor. The water should drain by gravity into the bowl. If the bowl is full, hook the hose back up and empty the bowl. Repeat the procedure until the water has drained from the machine.

Then check that the drain filter in the machine is not clogged.

If the machine empties as it fills...

Make sure the end of the drain hose is not less than 50cm (20") above floor level.

If the machine vibrates badly, or is too noisy...

Check that the machine is absolutely level.

Check that there is sufficient clearance between the machine and wall, furniture, etc.

Check that all the internal packing, plastic spacers and transit security bolts have been removed as described at the start of these instructions.

Besides these easy check-ups, the machine also offers a few alarm indications on the display (E):

IMPORTANT!

The "electronic control" incorporated in this machine checks, moment by moment, that it is functioning correctly.

Any malfunctioning is/are signalled as follows:

Should at any time an "Alarm" code (3A or 5A) appear on the display, **press START button for approx. 1 sec.** If Alarm code does not disappear:

Alarm Code	Problem	Solution
3A	Water not drained	Try cycle 23 (Drain). Check the drain hose and clean the drain filter, referring to the instructions "If the machine won't drain or spin" on the previous page 31. If, after checking the filter, the alarm persists, call your Service Agent.
5A	No water load	Check that the water tap is turned on, and that there is sufficient pressure and that the drain hose is not sharply bent, if the alarm persists call your Service Agent.

IN-GUARANTEE CUSTOMERS SHOULD ENSURE THAT THE ABOVE CHECKS HAVE BEEN MADE AS THE ENGINEER WILL MAKE A CHARGE IF THE FAULT IS NOT A MECHANICAL OR ELECTRICAL BREAKDOWN.

*** Please note that proof of purchase is required for any in-guarantee service calls.**

CAUTION

The "electronic control" signals all the possible malfunctions in the washing machine, including those which are temporary or caused by incorrect use of the programmes.

In this case, to restore correct functioning, simply cancel the programme and switch the machine off. Switch on again and then reselect a washing programme.

If the same malfunction persists, call your Service Agent.

Peace of mind for twelve months

ZANUSSI STANDARD GUARANTEE CONDITIONS

This guarantee is in addition to your statutory and other legal rights which will not be excluded or in any way diminished by the return of this guarantee card.

We, Zanussi Ltd, undertake that if, within twelve months of the date of the purchase, this ZANUSSI appliance or any part thereof is proved to be defective by reason only of faulty workmanship or materials, we will, at our option, repair or replace the same **FREE OF ANY CHARGE** for labour, materials or carriage on condition that:

- The appliance has been correctly installed and used only on the electricity supply stated on the rating plate.
- The appliance has been used for normal domestic purposes only, and in accordance with the manufacturer's operating and maintenance instructions.
- The appliance has not been serviced, maintained, repaired, taken apart or tampered with by any person not authorised by us.
- The appliance is still in the possession of the original purchaser.

All service work under this guarantee must be undertaken by a Zanussi Network Service Centre (or the Zanussi Authorised TV Service Dealer).

Any appliance or defective part replaced shall become our property.

Exclusions

- Damage or calls resulting from transportation, improper use or neglect, the replacement of any light bulbs or removable parts of glass or plastic.
- Costs incurred for calls to put right machines improperly installed or calls to machines outside the UK and the Republic of Ireland.
- Appliances found to be in use within a commercial environment, plus those which are the subject of rental agreements.
- Television receivers - routine adjustment, or poor reception resulting from a source outside of the receiver.

or five years

ZANUSSI 5 YEAR COVER CONDITIONS

For a once-only payment you can extend your Standard Guarantee to 5 years. All the conditions and exclusions of the Standard Guarantee apply.

Notes

1. Products supplied as «seconds», refurbished, damaged or shop-soiled are not eligible for Zanussi 5 Year Cover.
2. The issue of a cover does NOT by virtue of our having done so, nullify the exclusions.
3. The Engineer will need to check the details of your Cover card and may make a charge for his services if it is not presented to him at the time of his call.
4. The date of purchase, or the date of initial payment (deposit) of the appliance will be deemed the date of commencement of cover.
5. Covers issued are not refundable or transferable.

Guarantee Record

Appliance purchased from _____ on _____

Guarantee card no _____ Model no _____

Serial no _____ (These details may be taken from your Guarantee Record Card)

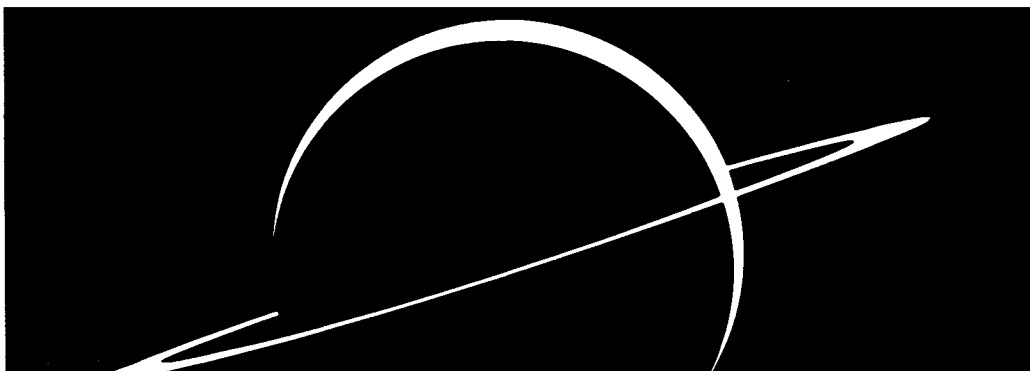

ZANUSSI

The appliance of science

Zanussi Ltd., Zanussi House, Newbury.

The information in this manual is correct at time of going to press.
Zanussi reserve the right to alter specifications without notice.